

Name: Floorstand PentaLock  
 Model Number: #17.1100/ #17.1102  
 Instructions ID: #00.5087\_B

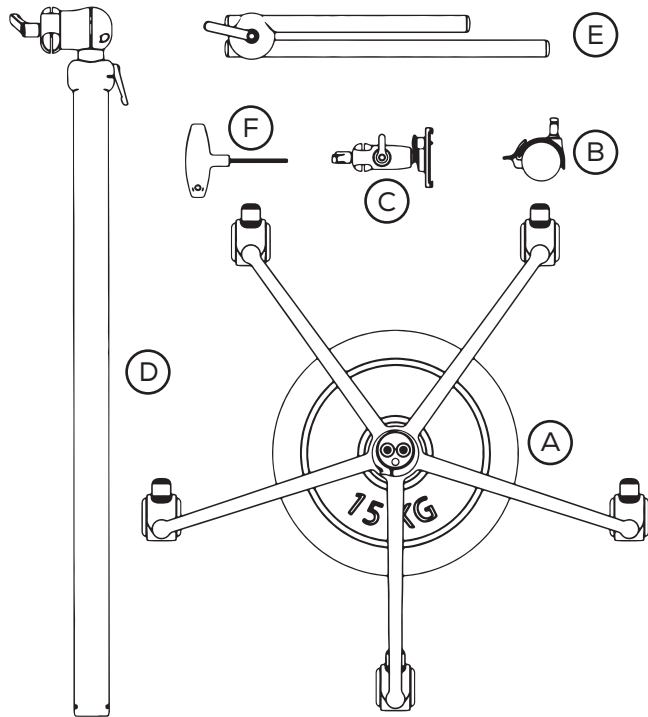

## **i** Mounting kit / Montageset

- (A) = 1x Base/Fuß
- (B) = 5x Casters/Rollen
- (C) = 1x UDS/UGA
- (D) = 1x Column/Säule
- (E) = 1x Arm
- (F) = 1x T-Handle/T-Griff

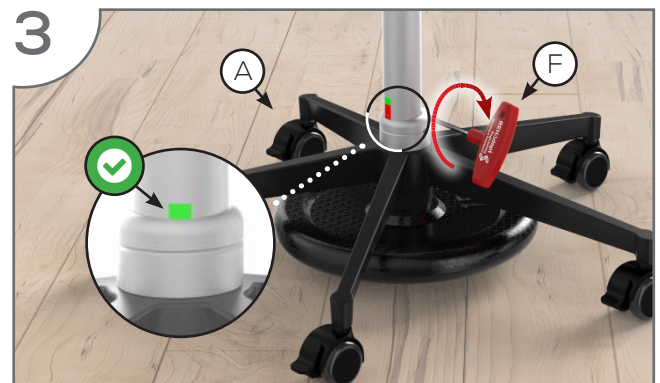
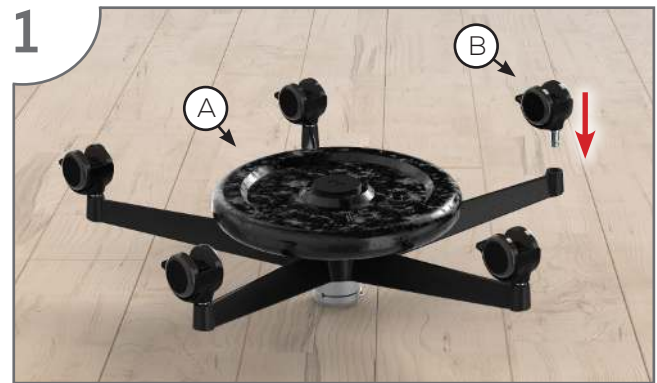

## **!** Attention / Achtung



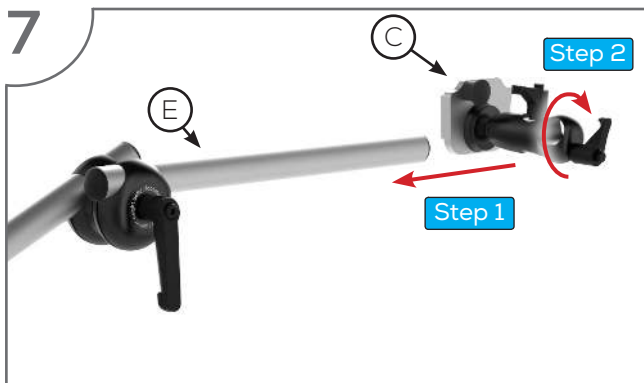
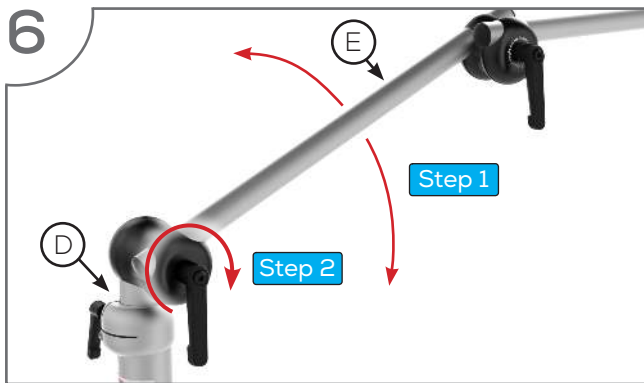
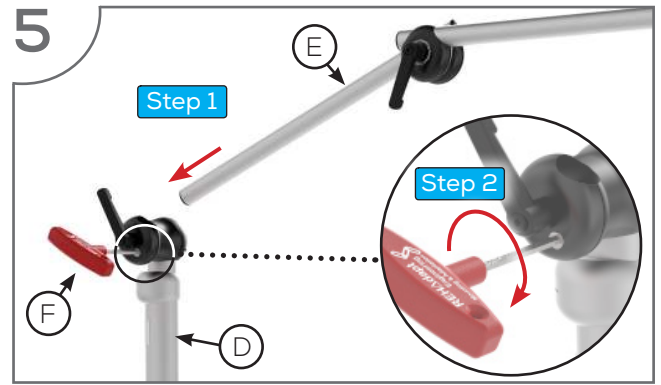
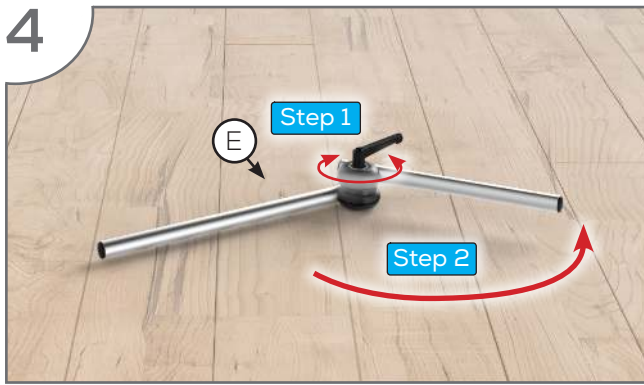

## Attention / Achtung



Do not adjust/operate any hinge with a device mounted!

Remove the device before adjusting!



Betätigung/Verstellung jeglicher Gelenke nur mit abgenommenem Gerät!

Bitte Gerät vorher abnehmen!